

**DEHOUST**

Leimen GmbH  
69181 Leimen  
Gutenbergstraße 5-7

TrioSafe 1100 / 1500  
Aufstellvarianten  
DE-A-01

Anlage  
zur allgemeinen  
bauaufsichtlichen  
Zulassung

vom

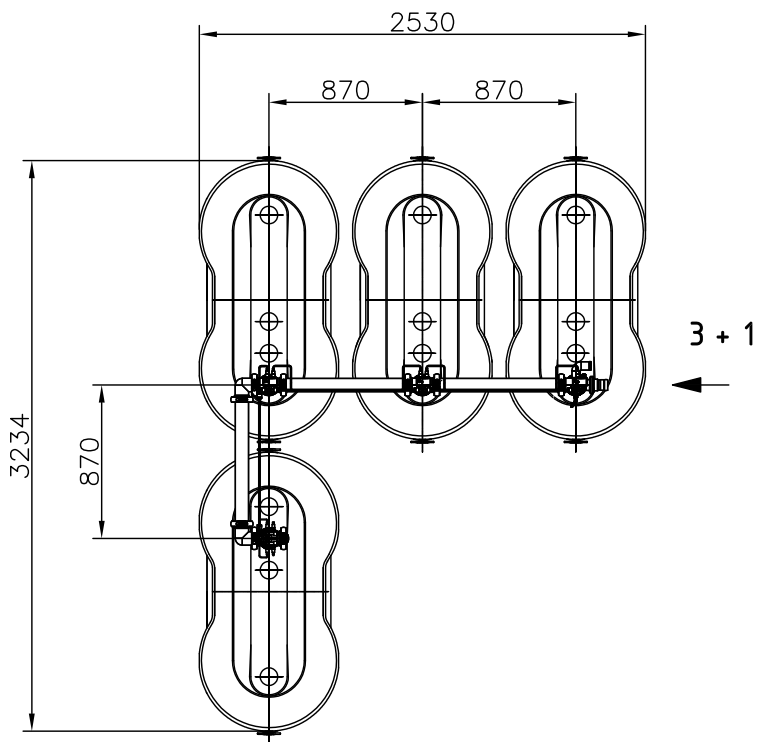
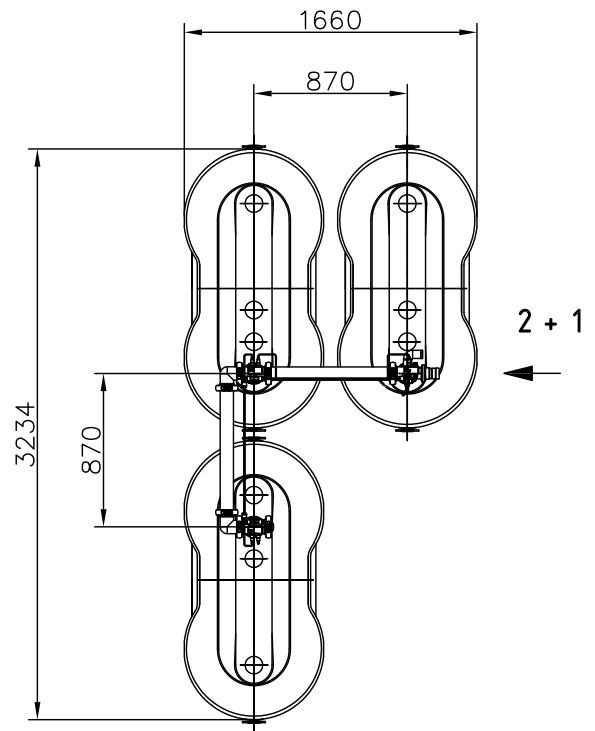
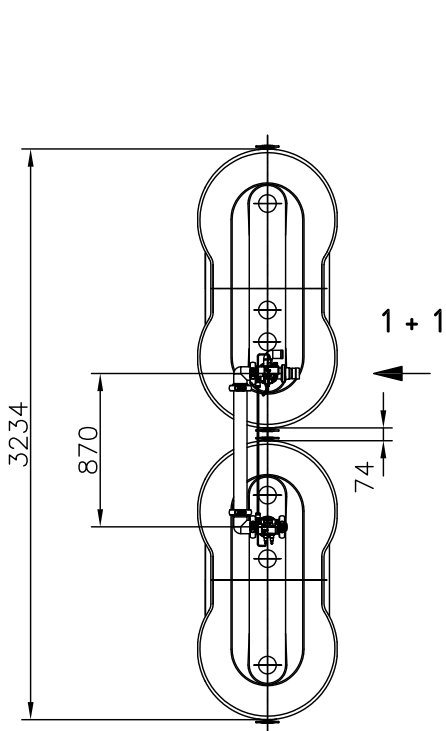

**DEHOUST**

Leimen GmbH  
69181 Leimen  
Gutenbergstraße 5-7

TrioSafe 1100 / 1500  
Aufstellvarianten  
DE-A-01

Anlage  
zur allgemeinen  
bauaufsichtlichen  
Zulassung

vom

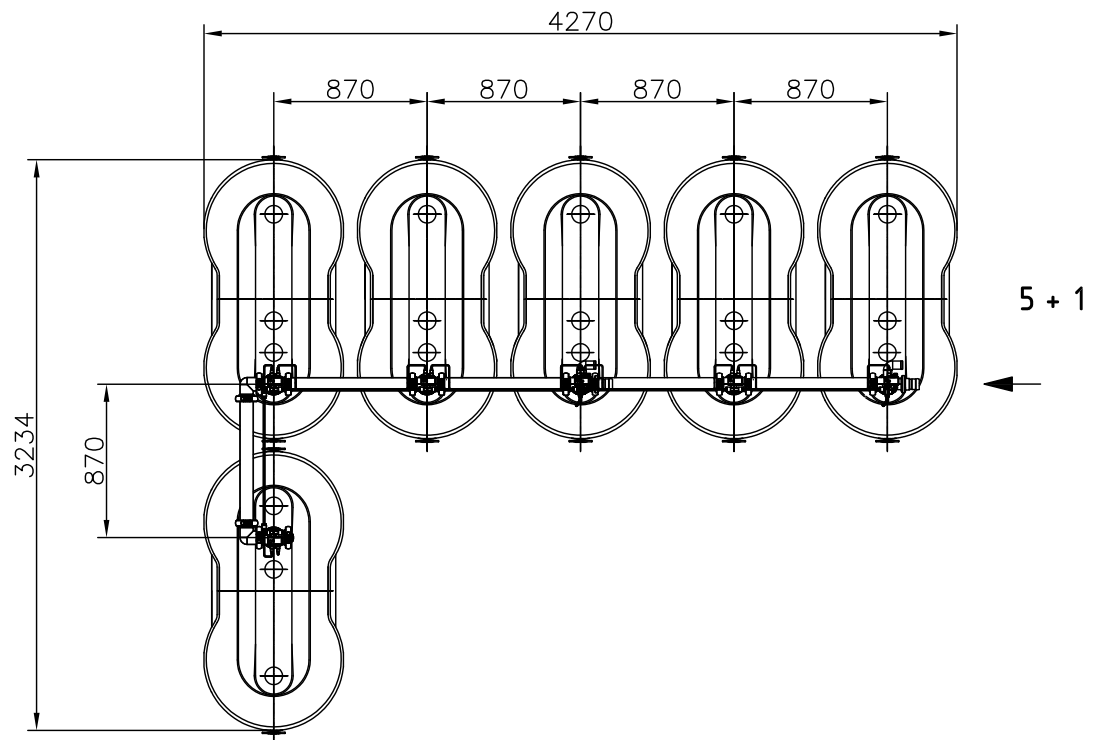
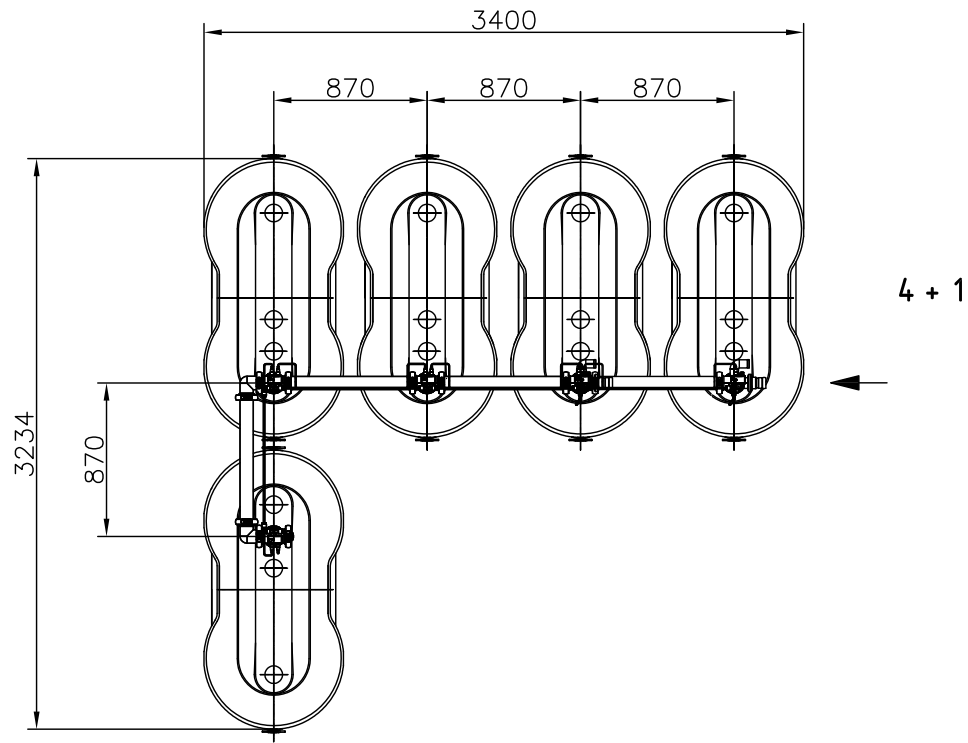

**DEHOUST**

Leimen GmbH  
69181 Leimen  
Gutenbergstraße 5-7

TrioSafe 1100 / 1500  
Aufstellvarianten  
DE-A-01

Anlage  
zur allgemeinen  
bauaufsichtlichen  
Zulassung

vom

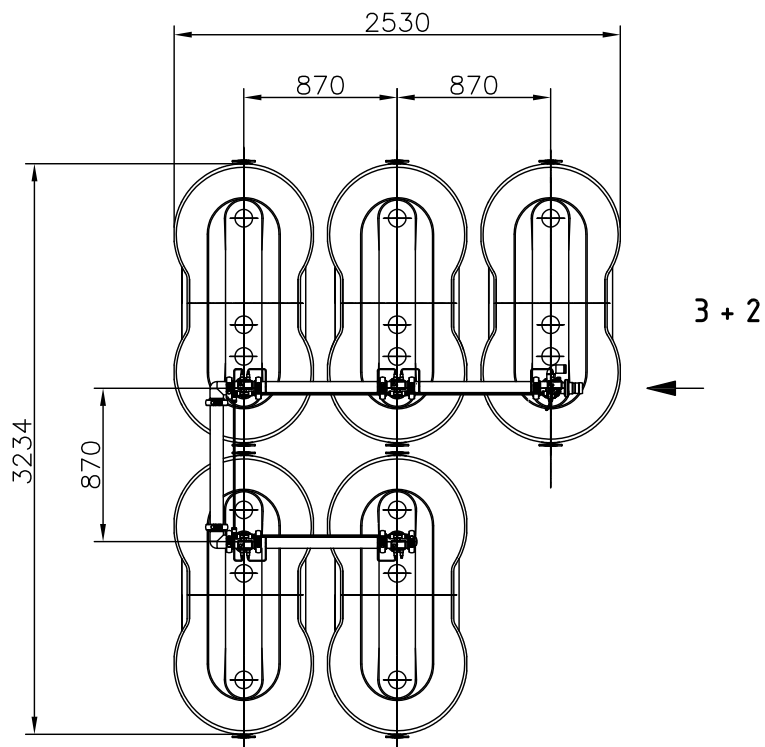
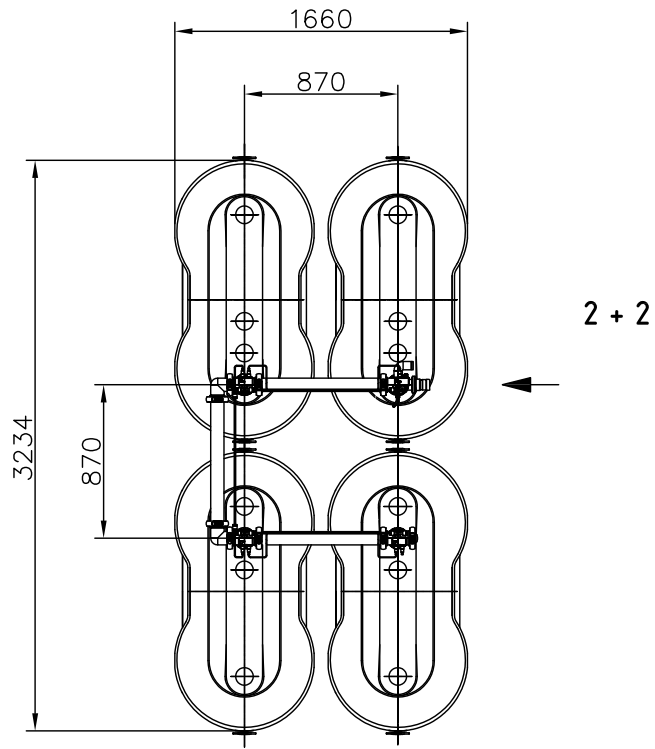

**DEHOUST**

Leimen GmbH  
69181 Leimen  
Gutenbergstraße 5-7

TrioSafe 1100 / 1500  
Aufstellvarianten  
DE-A-01

Anlage  
zur allgemeinen  
bauaufsichtlichen  
Zulassung

vom

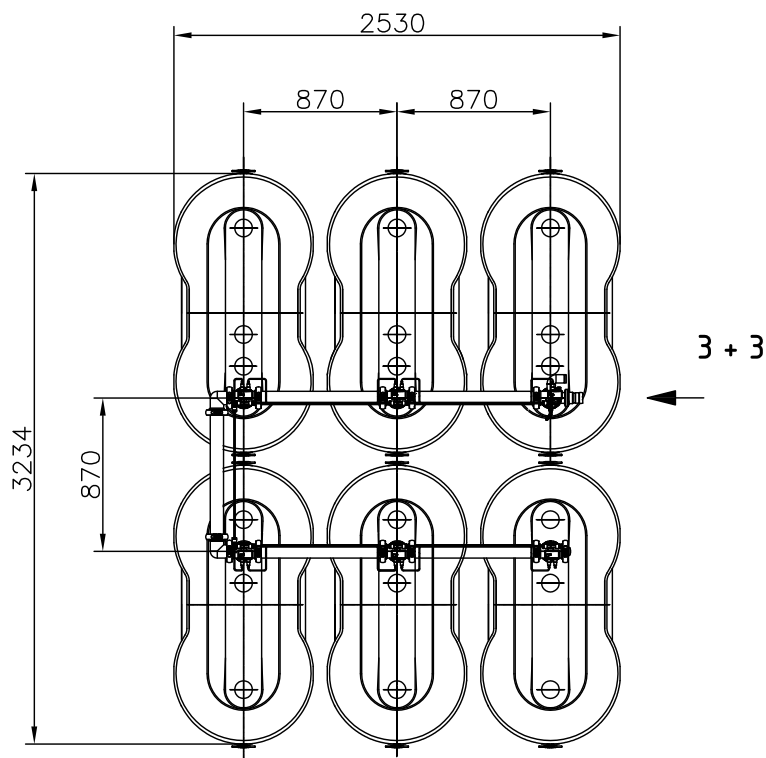
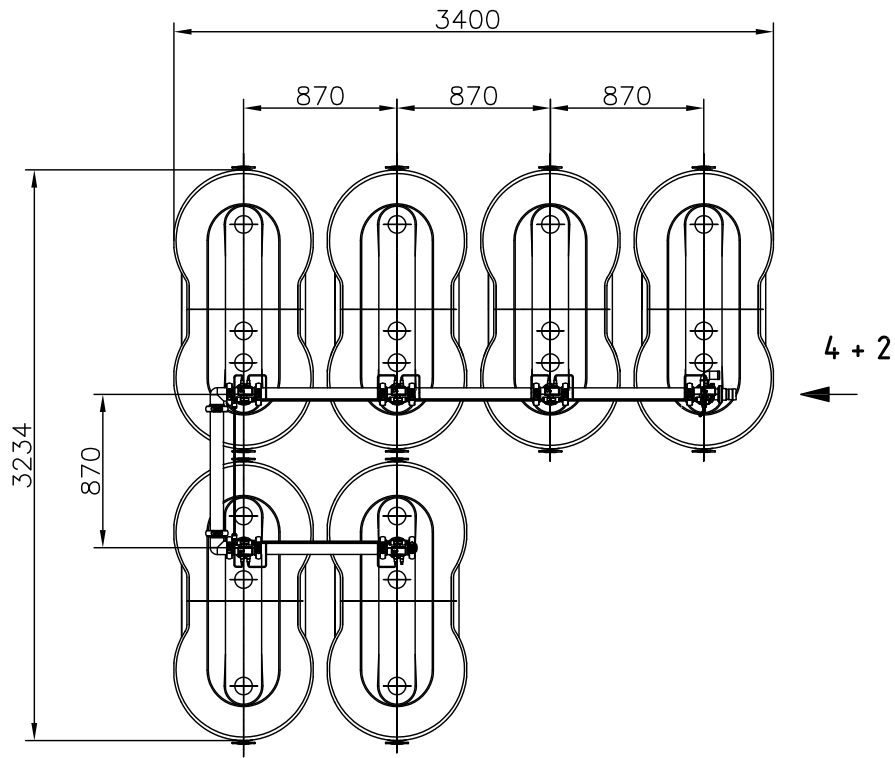

**DEHOUST**

Leimen GmbH  
69181 Leimen  
Gutenbergstraße 5-7

TrioSafe 1100 / 1500  
Aufstellvarianten  
DE-A-01

Anlage  
zur allgemeinen  
bauaufsichtlichen  
Zulassung

vom

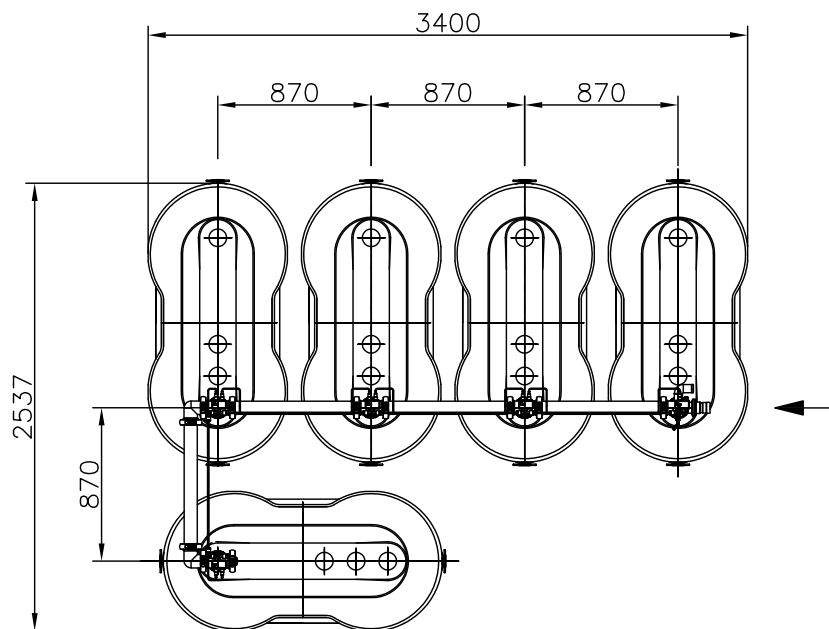
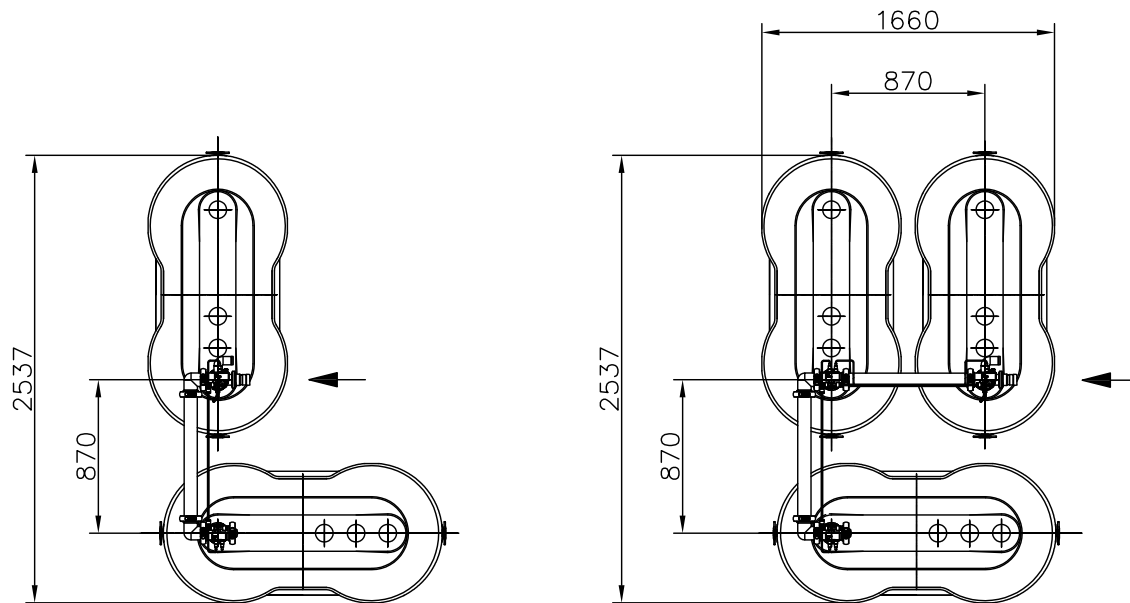

**DEHOUST**

Leimen GmbH  
69181 Leimen  
Gutenbergstraße 5-7

TrioSafe 1100 / 1500  
Sonderaufstellvarianten  
DE-A-01

Anlage  
zur allgemeinen  
bauaufsichtlichen  
Zulassung

vom